

planta baixa  
pav. térreo

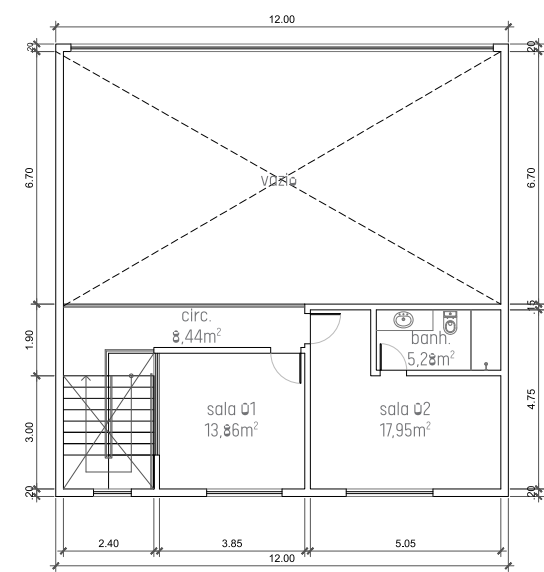

planta baixa  
mezanino

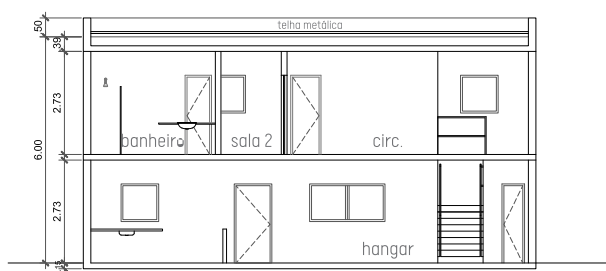

corte AA

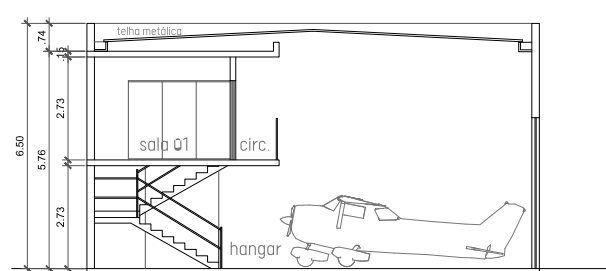

corte BB

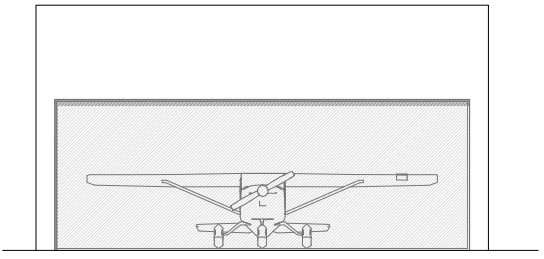
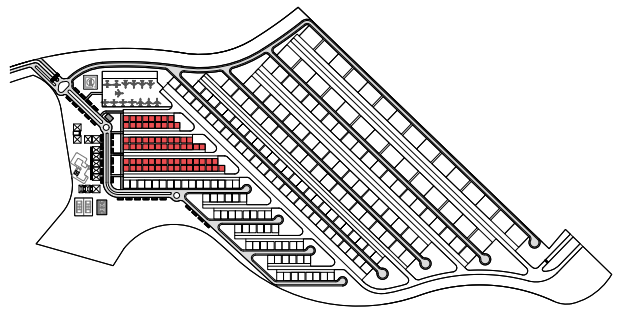

fachada 1

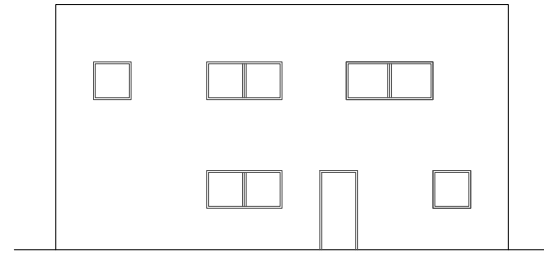

fachada 2

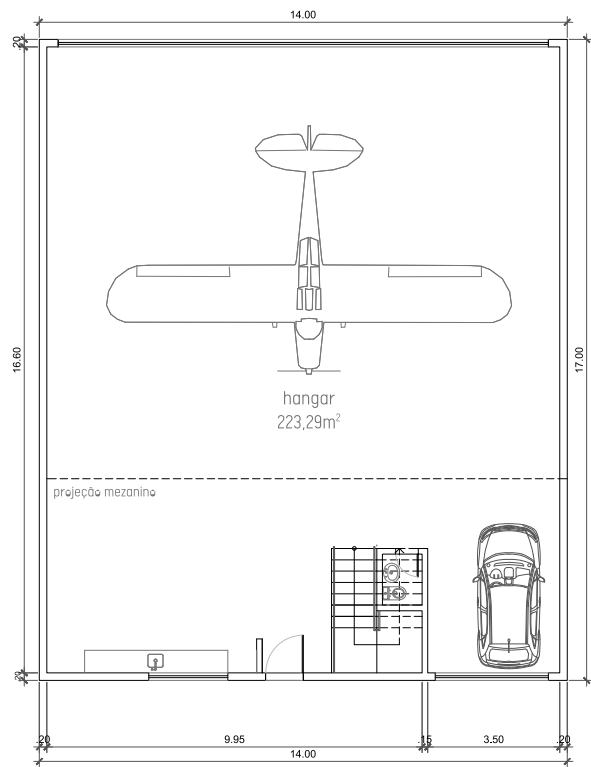

planta baixa  
pav.terreo

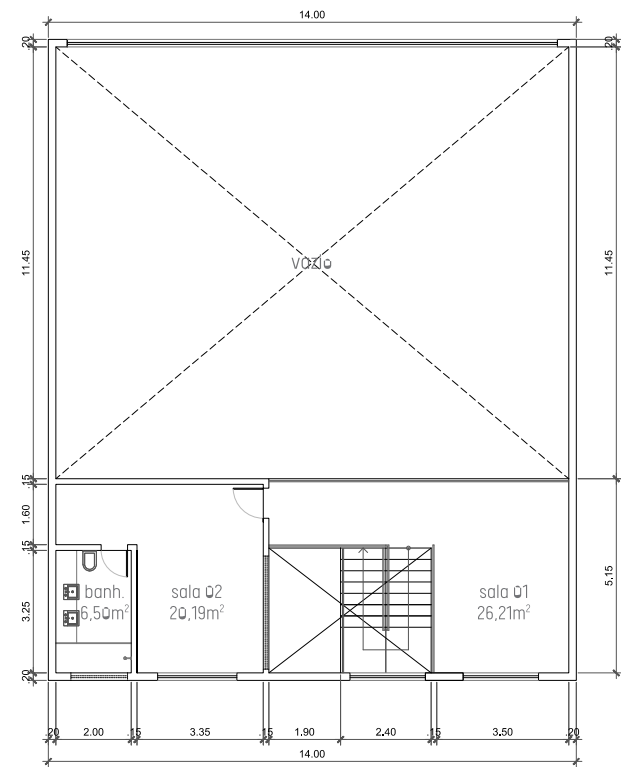

planta baixa  
mezanino



corte AA

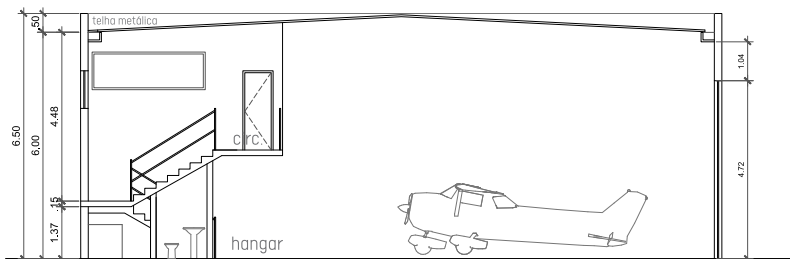

corte BB

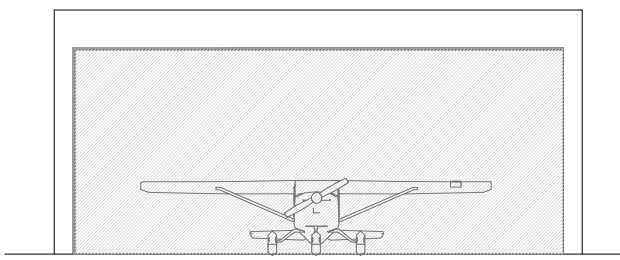
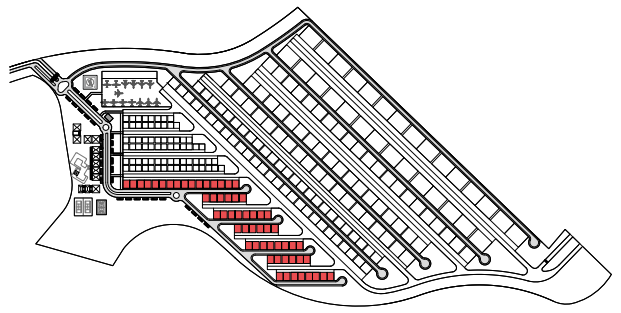

fachada 1

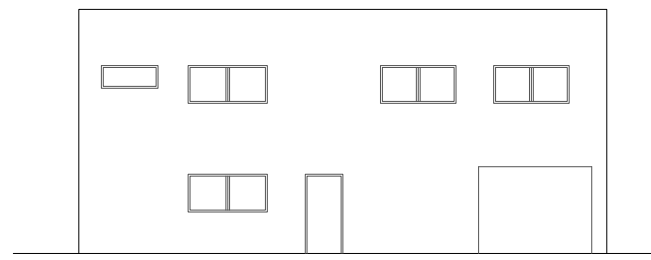

fachada 2

# HANGAR 3 (20X18m)

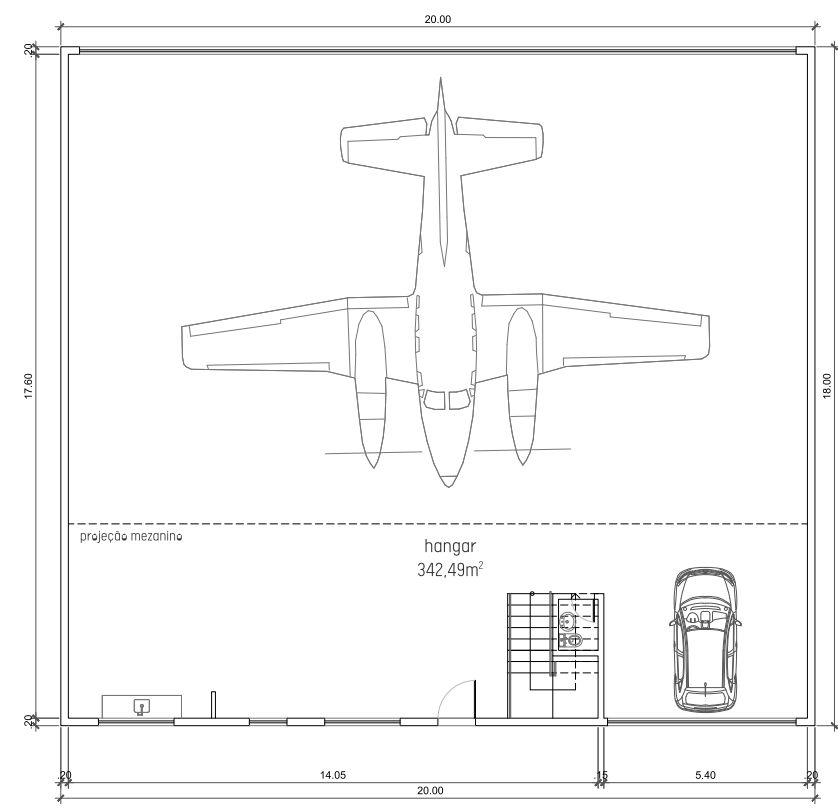

planta baixa pav.térreo

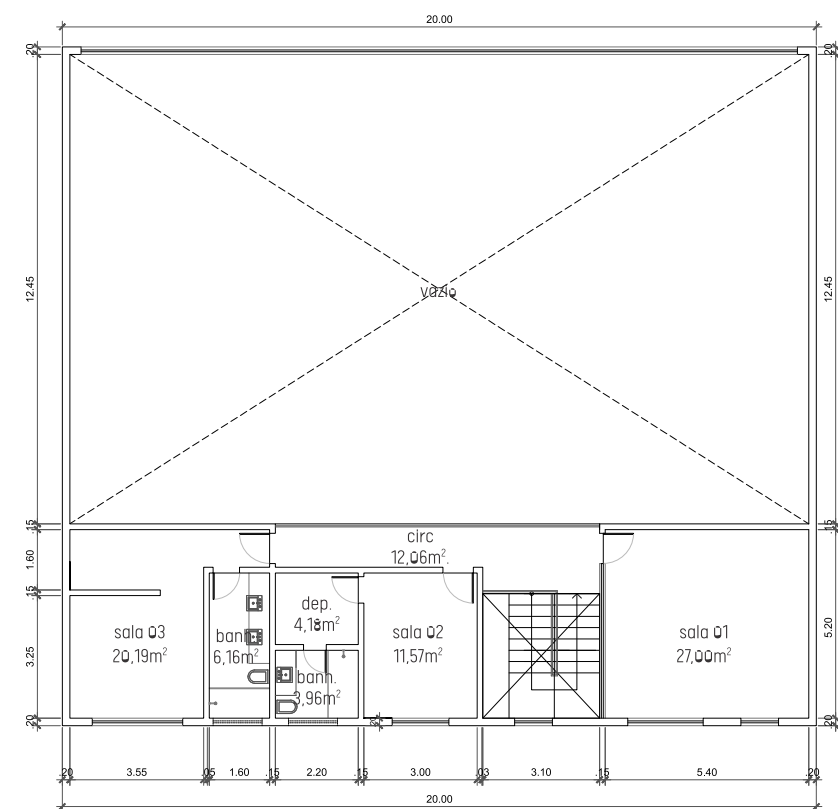

planta baixa mezanino

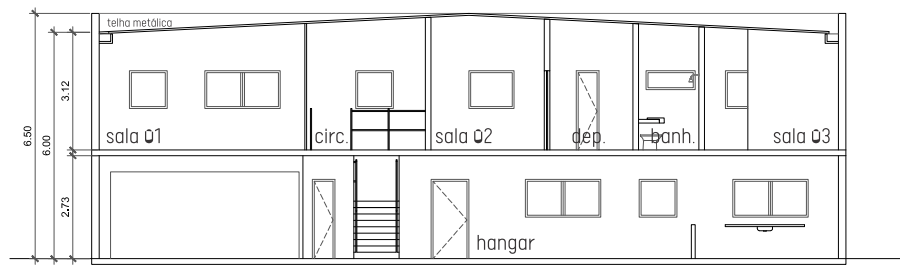

corte AA

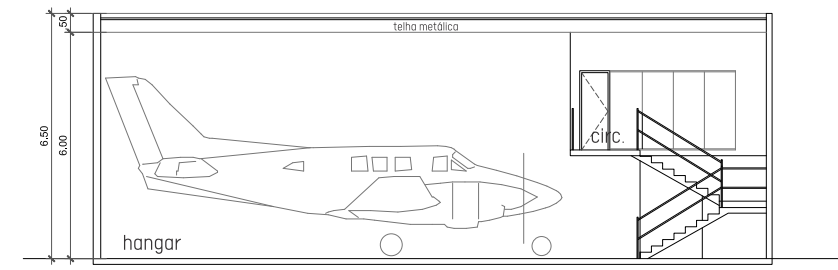

corte BB

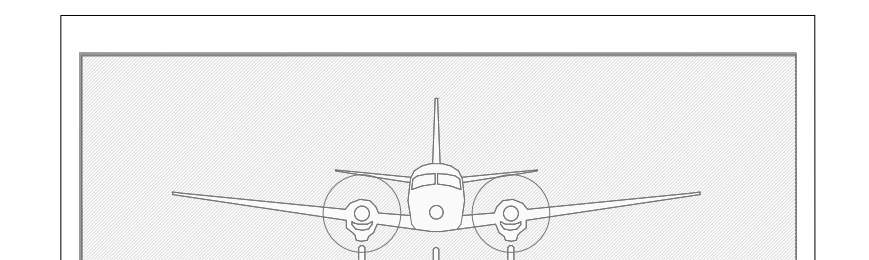
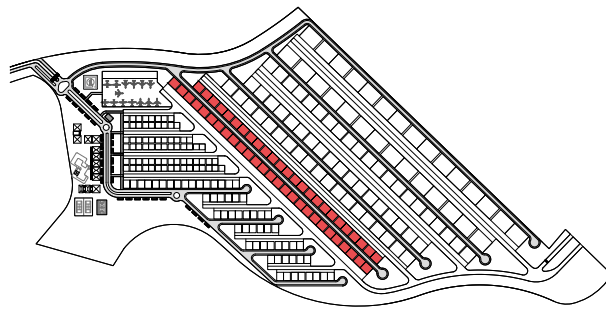

fachada 1

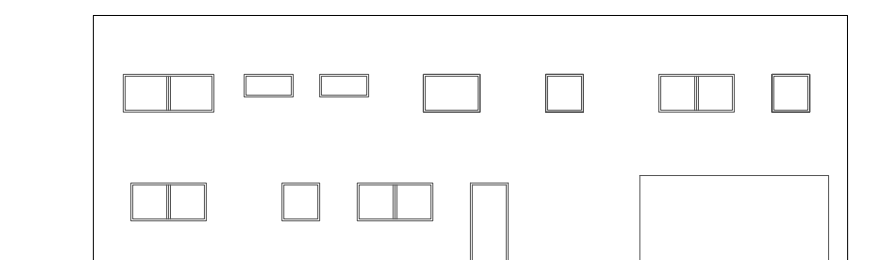

fachada 2

# HANGAR 4 (27X25m)

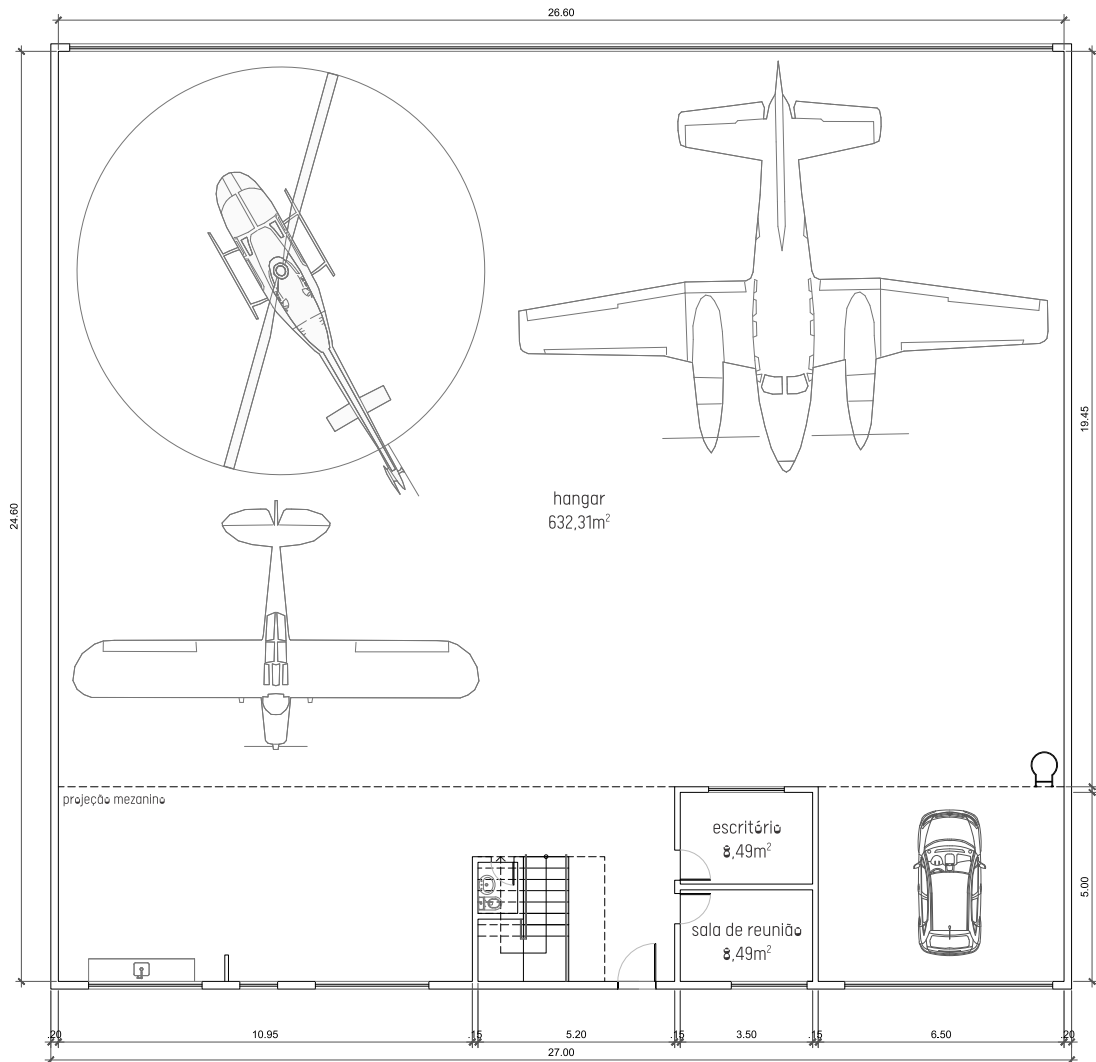

planta baixa pav. térreo

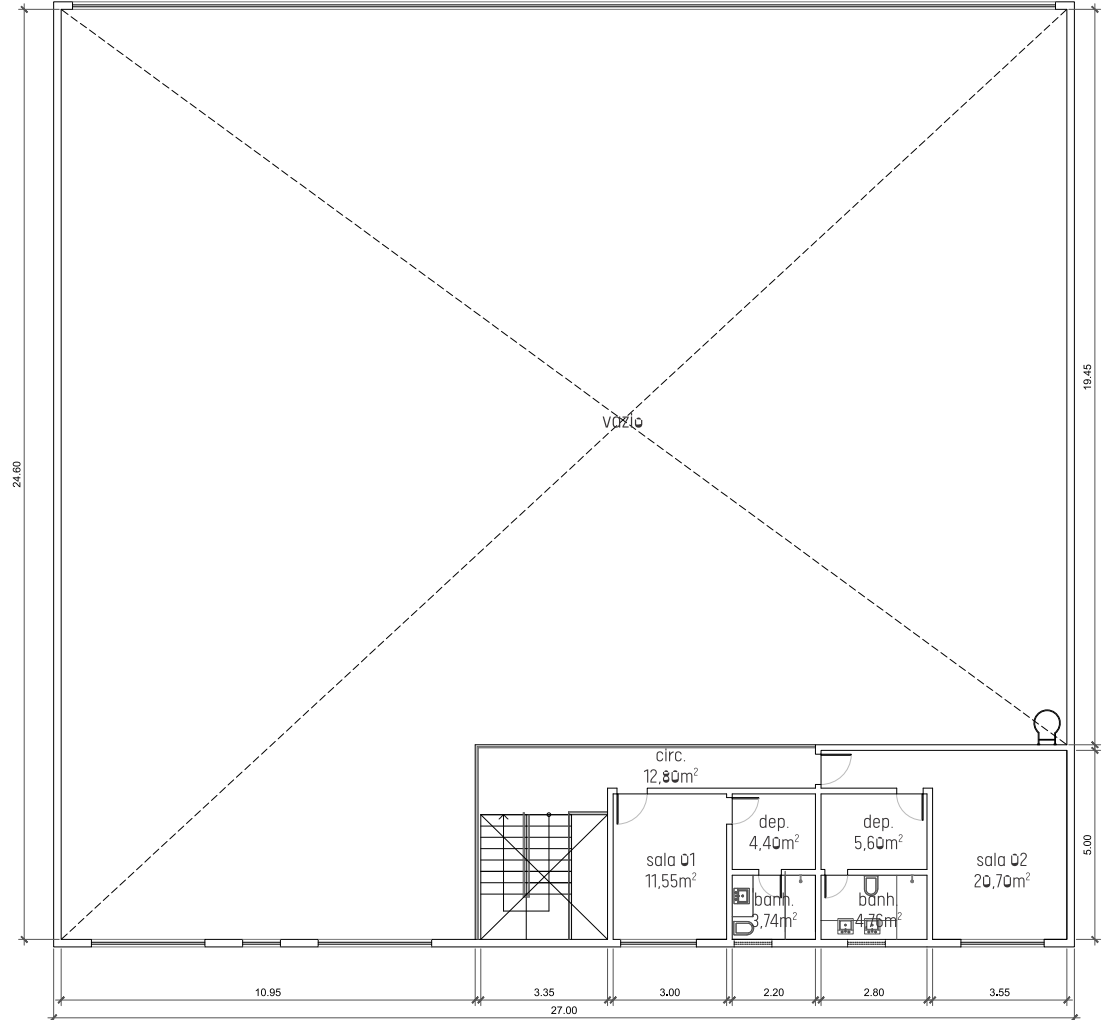

planta baixa mezanino

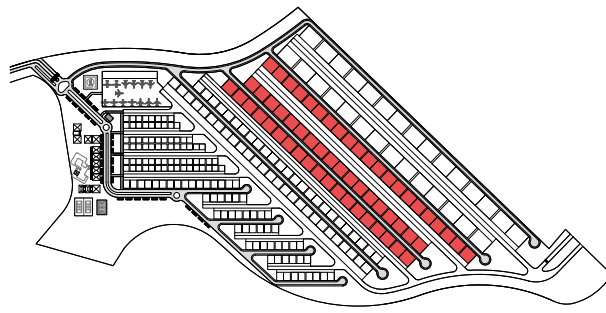

# HANGAR 4 (27X25m)

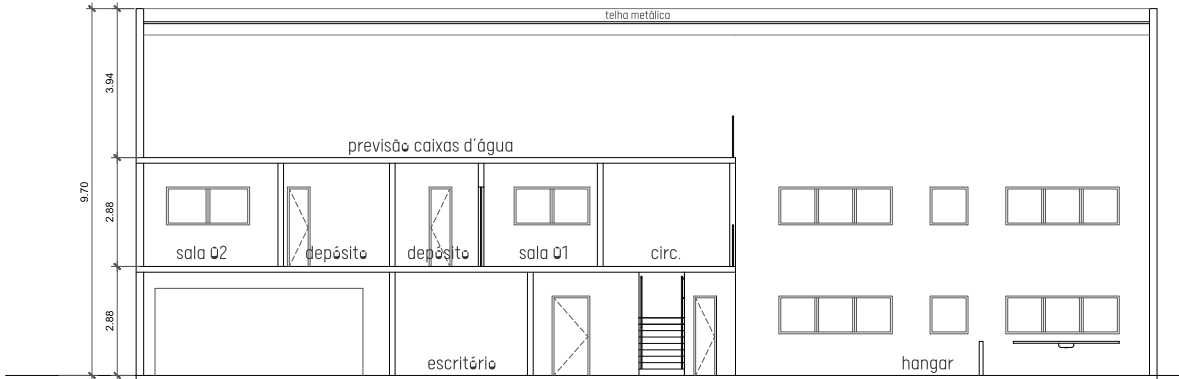

corte AA

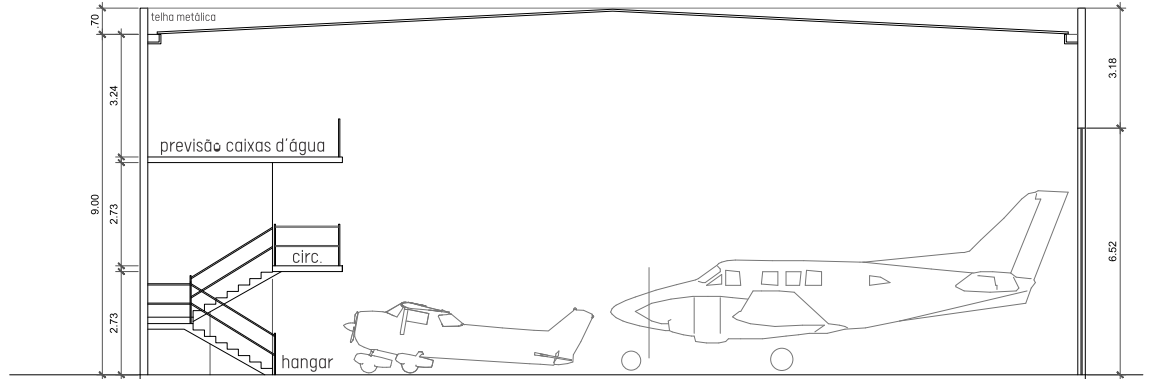

corte BB

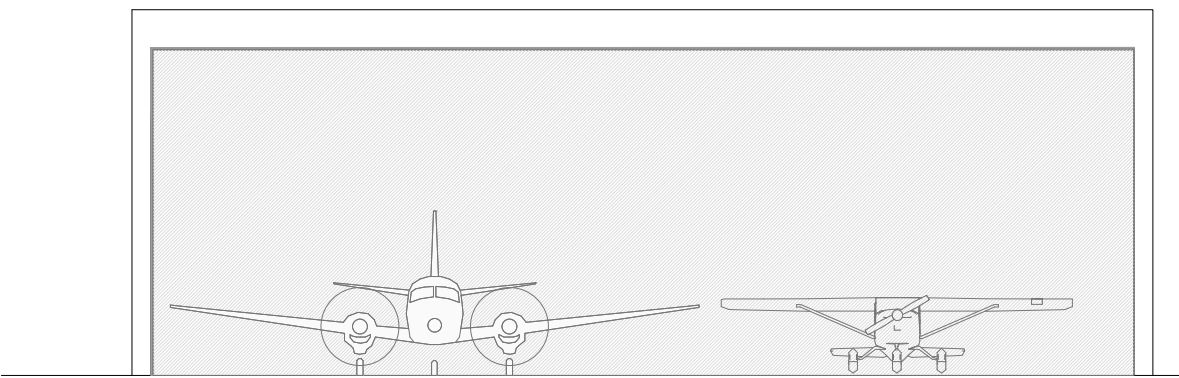

fachada 1

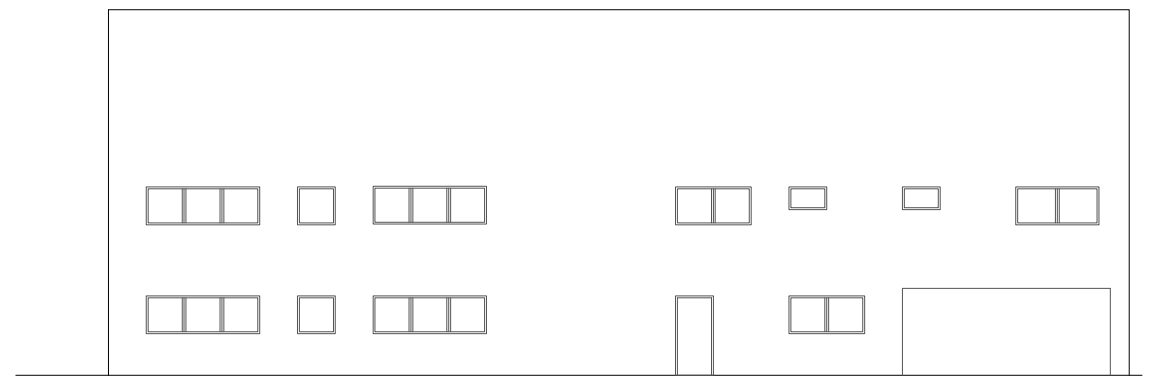

fachada 2

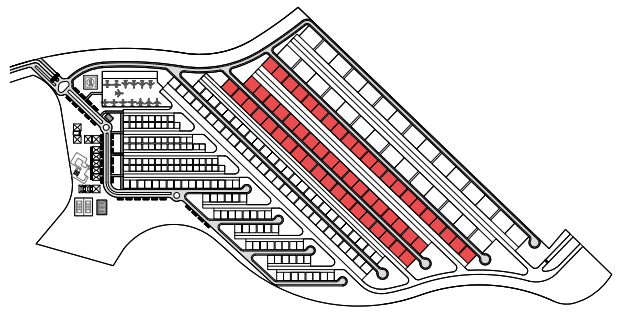

# HANGAR 5 (40X30m)

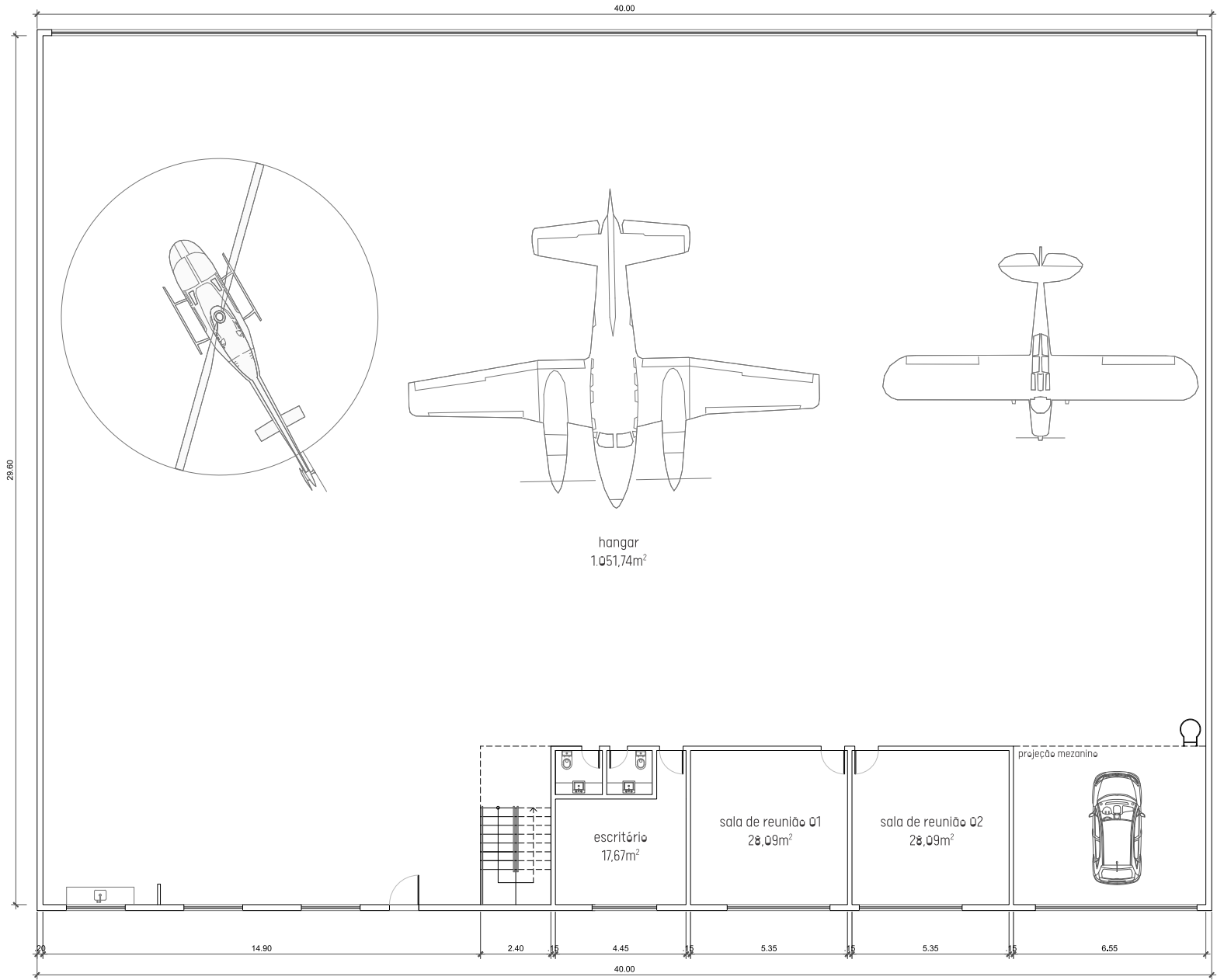

planta baixa  
pav.térreo

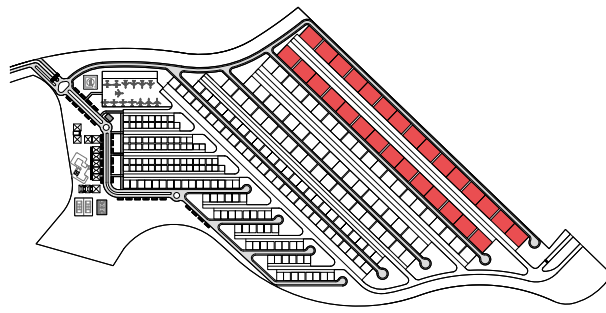

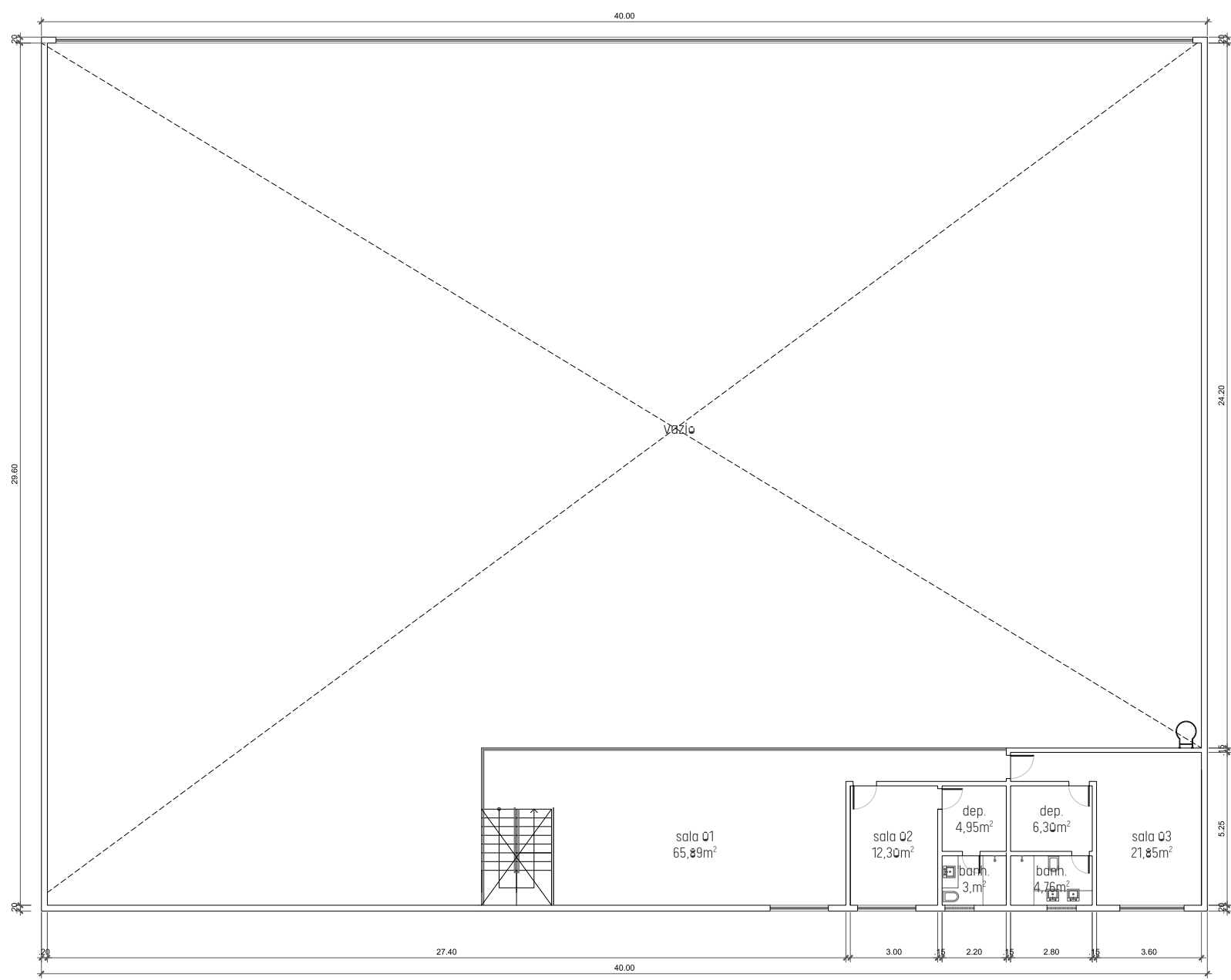

planta baixa  
mezanino

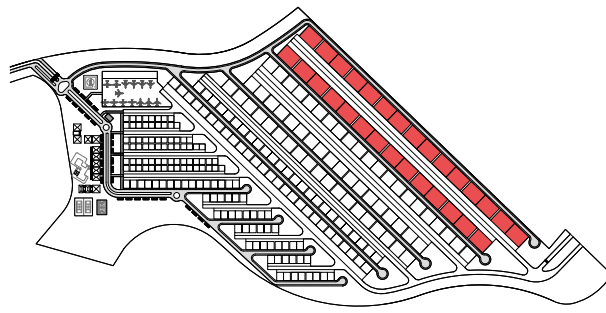

# HANGAR 5 (40X30m)

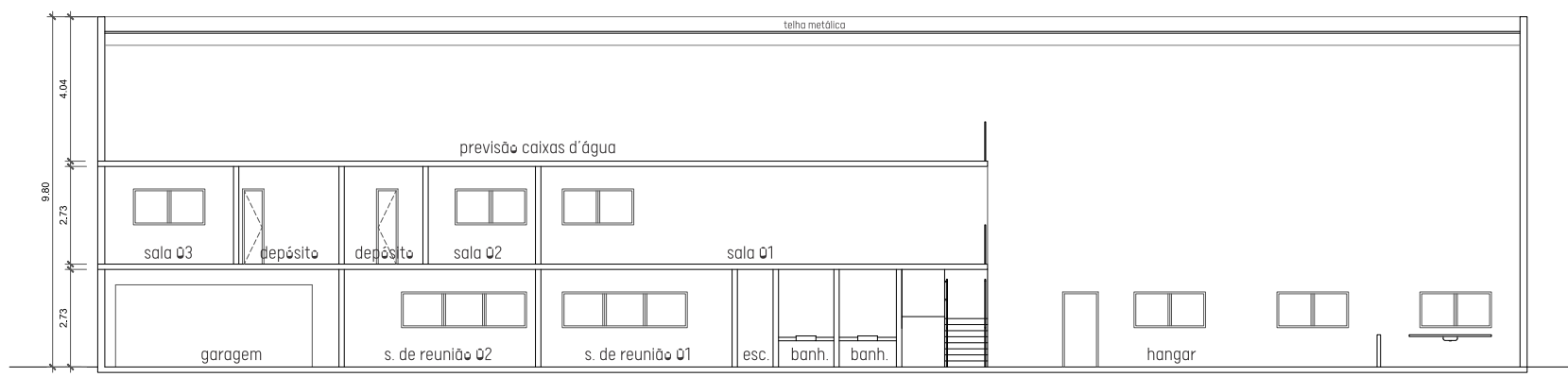

corte AA

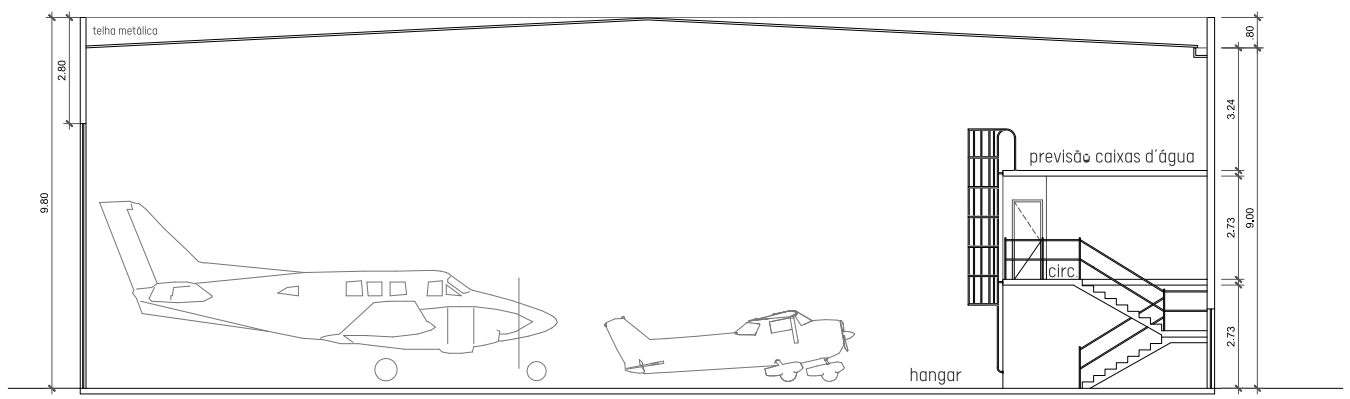

corte BB

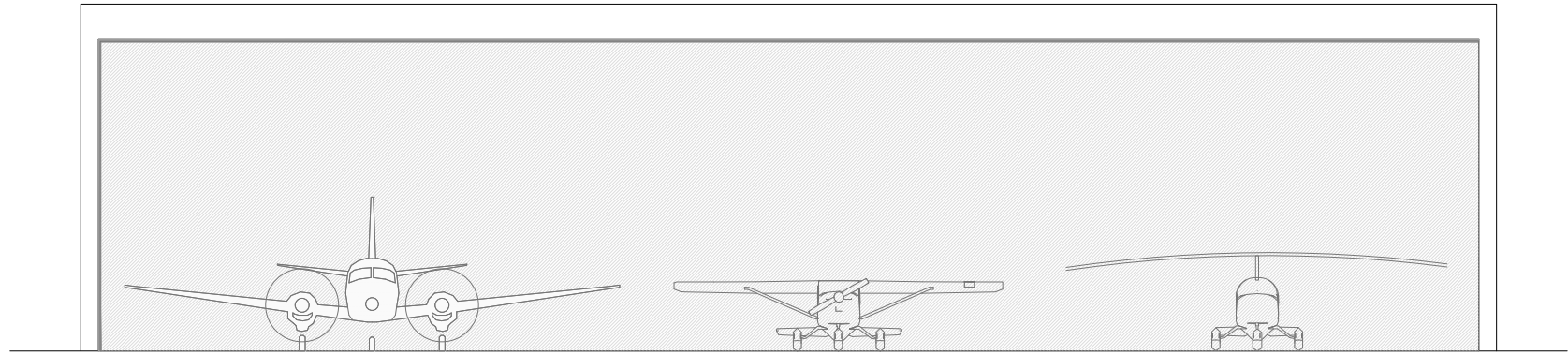

fachada 1

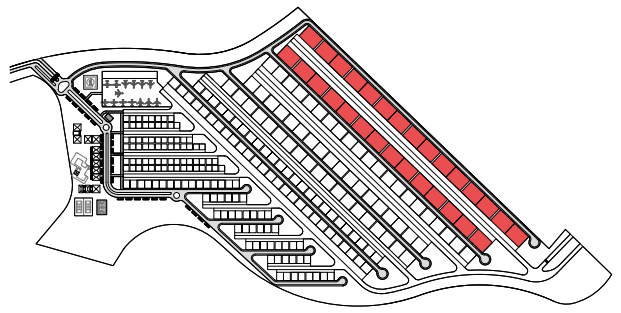

fachada 2